

# EWP Product Guide

USPconnectors.com

For Use With Products Manufactured by

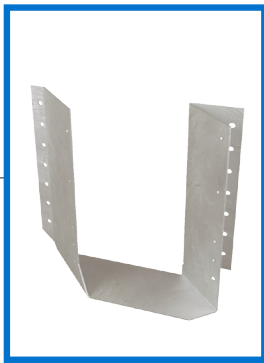

SKH2520R-2 ●

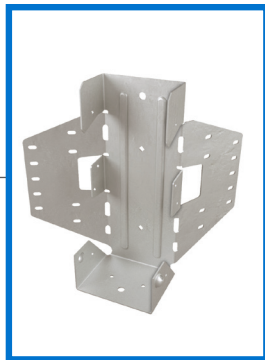

LSSH35 ●



THFI2514 ●



TFL25118 ●

# MiTek

## Canadian Specifiers Guide

Bradford • Thornhill • Surrey • Calgary • Edmonton • Laval • Dieppe

## Follow these instructions to ensure the proper installation of USP products.

- See current USP Product Catalog for General Notes, Warranty, and installation information for hanger models, joist sizes, and header situations not shown.
- Loads listed address hanger/header/fastener limitations as well as joist/hanger limitations assuming header material is Douglas Fir (DF) or LVL. For S-P-F header material, refer to the current USP catalog. Joist reaction should be checked by a qualified designer to ensure proper hanger selection.
- Uplift loads have been increased 15% for wind or seismic loads and no further increase shall be permitted. Reduce loads according to code for normal duration loading such as cantilever construction.
- If hanger height is less than 60% of joist height, joist rotation may occur, therefore supplemental lateral restraints are required, see page 3.
- The type and quantity of fasteners used to install USP products is critical to connector performance. To achieve the factored resistances shown in this document, install with the fasteners specified for that particular

- product. All specified fasteners must be properly installed prior to applying load of any kind to the connection.
- Throughout this document, dimensions are expressed in inches and loads in pounds, unless specifically noted otherwise.
- Load values for 10d and 16d designations in the fastener schedules throughout this document refer to common wire nails, unless noted otherwise.
- The factored resistances shown in this document are based on Limit States Design methodology.
- **Multiple Joist Plies:** Fasten together multiple plies of wood joists, in accordance with the manufacturer's installation guidelines, such that the joists act as a single unit.
- **Sloped Joists:** Use slope seat hangers and beveled web stiffeners whenever the slope exceeds the following: 1/2:12 for seat bearing lengths of 2 1/2" or less; 3/8:12 for bearing lengths between 2 1/2" and 3 1/2"; and 1/4:12 for bearing lengths in excess of 3 1/2".

**Backer Blocks** – Pattern the nails used to install backer blocks or web stiffeners in wood Joists to avoid splitting the block. The nail pattern should be sufficiently spaced to avoid the same grain line, particularly with solid sawn backer blocks. Backer blocks must be installed on wood Joists acting as the header, or supporting member. Install in accordance with the I-Joist manufacturer's installation guidelines. The nails used to install hangers mounted to a Joist header must penetrate through the web and into the backer block on the opposite side.

**Backer Block Installation:**  
(minimum 12" wide)  
Nail with (10) 8d nails  
(use 10d nails for flanges  
wider than 2-1/2")

**Filler Block Installation:**  
Nail with 8d nails (10d for flanges  
wider than 2-1/2") spaced 6" oc  
per row. Drive every other nail  
from opposite sides.

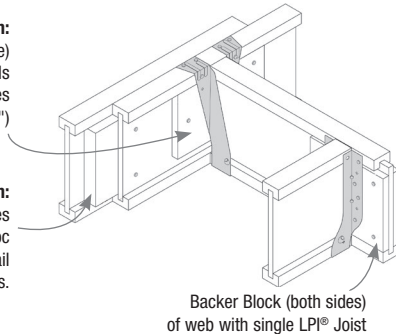

Backer Block (both sides)  
of web with single LPI® Joist

Filler and Backer Block Sizes		
LPI Series	Filler Block Thickness	Backer Block Thickness
LPI 18 LPI 20Plus LPI 32Plus	2-1/8"	1"
LPI 42Plus LPI 52Plus	3"	1-1/2"
LPI 56	3"	1-1/2"

With top flange hangers, backer block required only for factored downward loads exceeding 360 lbs or for uplift conditions

- Backer blocks and filler blocks shall consist of APA Rated wood structural panel (OSB or plywood), or 2x lumber (SPF or better).
- LP LVL, LSL or OSB Rim Board may also be used.

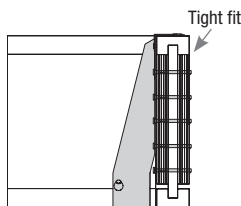

Typical THO (top mount)  
backer block installation

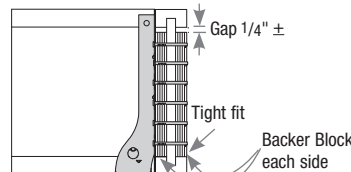

Typical THF (face mount)  
backer block installation

## Web Stiffener Attachment –

**Web Stiffeners are optional except as noted below:**

- Web stiffeners required at bearing locations for 18" & 24" deep joists.
- Web stiffeners are always required in hangers that do not extend up to support the top flange of the LPI® Joist. Web stiffeners may be required with certain sloped or skewed hangers or to achieve uplift values. Refer to USP's installation requirements.

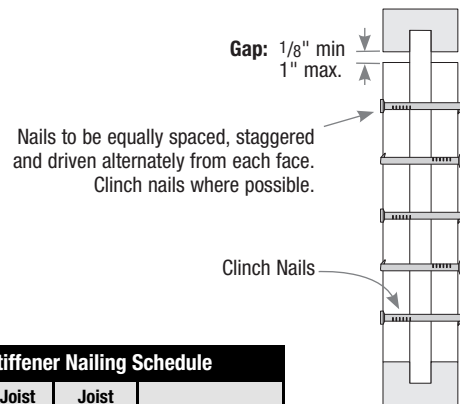

Web Stiffener Nailing Schedule			
LPI Series	Joist Width	Joist Height	Nailing
LPI 18 LPI 20Plus LPI 32Plus	2-1/2	9-1/2	(3) 8d (2-1/2")
		11-7/8	
		14	
		16	
LPI 42Plus LPI 52Plus	3-1/2	9-1/2	(3) 10d (3")
		11-7/8	
		14	
		16	
LPI 56	3-1/2	11-7/8	(4) 10d (3")
		14	(5) 10d (3")
		16	(6) 10d (3")

- Web stiffeners shall be cut from APA Rated OSB (or equal) or from LP LVL, LSL, or OSB Rim Board.
- For joist depths not shown in this table, consult Louisiana-Pacific for nailing schedule.

## Support Height & Lateral Stability

Hangers for joists **without web stiffeners** must support the I-joist's top flange and provide lateral resistance with no less than 1/8" contact.

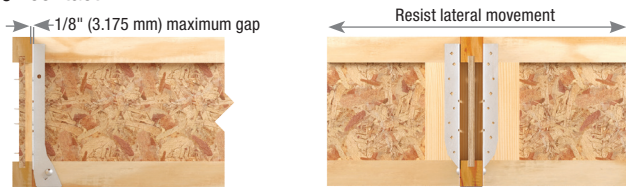

Hangers for joists **with web stiffeners** must support a minimum of 60% of joist depth or potential joist rotation must be addressed.

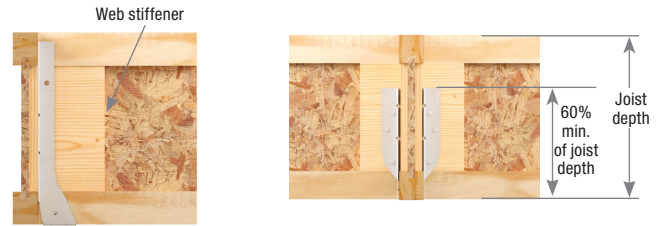

(Top flange support requirements can be verified in *EWP Top Mount Hangers* charts under the *Web Stiffener Req.* column of USP's *Product Catalog*.)

## Nailer Installations

### Correct Hanger Attachment to Nailer

A nailer or sill plate is considered to be any wood member attached to a steel beam, concrete block wall, concrete stem wall, or other type of support unsuitable for nailing which is used as a nailing surface for top mount hangers to hold beams or joists.

### Nailer Sized Correctly

Top flange of hanger is fully supported and recommended nails have full penetration into nailer, resulting in a carried member hanging safely at the proper height.

The nailer must be sized to fit the support width as shown and be of sufficient thickness to satisfy recommended top flange nailing requirements. A design professional must specify nailer attachment to steel beams.

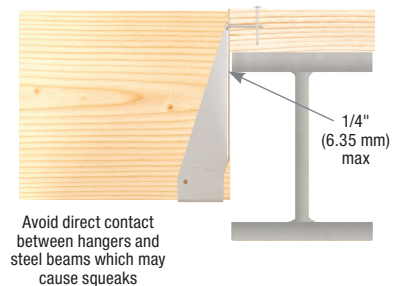

## Wrong Nailer Size Causes Component Failure

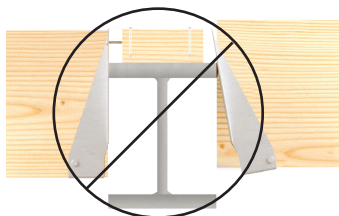

### ⚠ Too Narrow

Top flange not fully supported can cause nail breakout. Or, by fully supporting top flange, hanger is tilted back, causing lifting of carried member which results in uneven surfaces and squeaky floors.

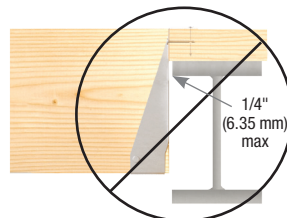

### ⚠ Too Wide

Loading can cause cross grain breaking of nailer. The recommended nailer overhang is 1/4" (6.35mm) maximum per side.



### ⚠ Too Thin

Top flange nailing cannot fully penetrate nailer, causing reduced factored resistance. Never use hangers which require multiple face nails with a nailer or sill plate since the factored resistance are dependent on all nail holes being used.

## Top Flange Hangers

The thickness of the hanger metal and nail heads on top mount hangers must be evaluated for the effect on subsequent sheathing. Ensure the top mount hanger is installed so the flanges of the hanger are not *over-spread* which tends to elevate the supported I-Joist, causing uneven floor surfaces and squeaking. Similarly, ensure the hanger is installed plumb such that the face flanges of the hanger are mounted firmly against the wide-face surface of the header.



Flush framing

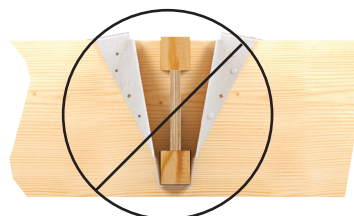

### ⚠ Hanger over-spread

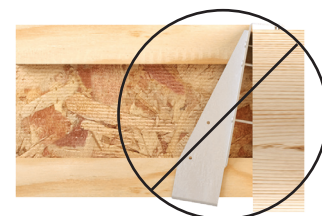

### ⚠ Hanger not plumb

## Hanger Factored Resistance (Lbs)

Joist Height	Top Mount Hangers <sup>4,6</sup>								Face Mount Hangers							
	USP Stock No. <sup>1</sup>	Length of Hanger Seat (in)	Fastener Schedule <sup>5</sup>				Uplift <sup>3</sup> 115%	Down <sup>2</sup> 100%	USP Stock No. <sup>1</sup>	Length of Hanger Seat (in)	Fastener Schedule <sup>5</sup>				Uplift <sup>3</sup> 115%	Down <sup>2</sup> 100%
			Header		Joist						Header		Joist			
			Qty	Type	Qty	Type					Qty	Type	Qty	Type		
<b>LPI 18, LPI 20PLUS, LPI 32PLUS</b>																
<b>Joist Width = 2-1/2"</b>																
9-1/2	TFL2595	2	6	10d	2	10d x 1-1/2	265	2370	THFI2595	2	8	10d	--	--	235	2345
11-7/8	TFL25118	2	6	10d	2	10d x 1-1/2	265	2370	THFI25118	2	10	10d	--	--	235	2345
14	TFL2514	2	6	10d	2	10d x 1-1/2	265	2370	THFI2514	2	12	10d	--	--	235	4605
16	TFL2516	2	6	10d	2	10d x 1-1/2	265	2370	THF26160	2-1/2	22	10d	2	10d x 1-1/2	690	4405
<b>LPI 42PLUS, LPI 52PLUS, LPI 56</b>																
<b>Joist Width = 3-1/2"</b>																
9-1/2	THO35950	2-3/8	10	10d	2	10d x 1-1/2	485	2950	THF35925	2-1/2	12	10d	2	10d x 1-1/2	445	5075
11-7/8	THO35118	2-3/8	10	10d	2	10d x 1-1/2	485	2950	THF35112	2-1/2	16	10d	2	10d x 1-1/2	445	5075
14	THO35140	2-3/8	12	10d	2	10d x 1-1/2	485	2950	THF35140	2-1/2	20	10d	2	10d x 1-1/2	445	6680
16	THO35160	2-3/8	12	10d	2	10d x 1-1/2	485	2950	THF35157	2-1/2	22	10d	2	10d x 1-1/2	445	6680
18	TFI418	2-1/2	6	16d	2	10d x 1-1/2	505	3685	THF35165	2-1/2	24	10d	8	10d x 1-1/2	2335	6680
20	TFI420	2-1/2	6	16d	2	10d x 1-1/2	505	3685	THF35165	2-1/2	24	10d	8	10d x 1-1/2	2335	6680
22	TFI422	2-1/2	10	16d	2	10d x 1-1/2	505	4675	THF35165	2-1/2	24	10d	8	10d x 1-1/2	2335	6680
24	TFI424	2-1/2	10	16d	2	10d x 1-1/2	505	4675	THF35165	2-1/2	24	10d	8	10d x 1-1/2	2335	6680

- 1) Shaded hangers require web stiffeners at joist ends. Web stiffeners may be required for non-shaded hangers by I-joist manufacturers.
- 2) Factored resistance is based on hanger attachment to a DF species solid sawn or LP® LVL header.
- 3) Factored uplift resistances have been increased 15% for short-term loads such as wind and earthquake; reduce for other load durations in accordance with the code.
- 4) Top Mount Hangers assume supporting headers to have a minimum height of 5-1/2" and a minimum thickness of the length of the header nails or the depth of the top flange, whichever is greater. For wood nailer options or header materials not included in this table, refer to the current USP Product Catalog.
- 5) 10d x 1-1/2 nails are 0.148" dia. x 1-1/2" long, 10d nails are 0.148" dia. x 3" long, and 16d nails are 0.162" dia. x 3-1/2" long. 16d sinkers are 0.148" dia. x 3-1/4" long and may be used where 10d commons are specified.
- 6) For top mount hangers supported by I-Joist headers with a flange thickness less than 1-1/2", consult USP and Louisiana-Pacific for hanger limitations.

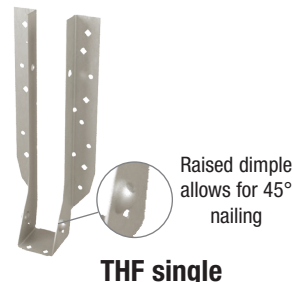

## Hanger Factored Resistance (Lbs)

Joist Height	Adjustable Height Hangers								Skewed 45° Hangers							
	USP Stock No. <sup>1,7</sup>	Length of Hanger Seat (in)	Fastener Schedule <sup>4</sup>				Uplift <sup>3</sup> 115%	Down <sup>2</sup> 100%	USP Stock No. <sup>1</sup>	Length of Hanger Seat (in)	Fastener Schedule <sup>4</sup>				Uplift <sup>3</sup> 115%	Down <sup>2</sup> 100%
			Header		Joist						Header		Joist			
			Qty	Type	Qty	Type					Qty	Type	Qty	Type		
<b>LPI 18, LPI 20PLUS, LPI 32PLUS</b>																
<b>Joist Width = 2-1/2"</b>																
9-1/2	MSH322	1-3/4	6	10d	4	10d x 1-1/2	--	3370	SKH2520L/R	1-7/8	14	10d	10	10d x 1-1/2	2855	3440
11-7/8	MSH322	1-3/4	6	10d	4	10d x 1-1/2	--	3370	SKH2520L/R	1-7/8	14	10d	10	10d x 1-1/2	2855	3440
14	MSH322	1-3/4	6	10d	4	10d x 1-1/2	--	3370	SKH2524L/R	1-7/8	16	10d	10	10d x 1-1/2	2855	4640
16	MSH322	1-3/4	6	10d	4	10d x 1-1/2	--	3370	SKH2524L/R	1-7/8	16	10d	10	10d x 1-1/2	2855	4640
<b>LPI 42PLUS, LPI 52PLUS</b>																
<b>Joist Width = 3-1/2"</b>																
9-1/2	MSH422	1-3/4	6	10d	6	10d	--	3215	SKH410L/R <sup>6</sup>	2-1/2	16	16d	10	10d	2855	4130
11-7/8	MSH422	1-3/4	6	10d	6	10d	--	3215	SKH410L/R <sup>6</sup>	2-1/2	16	16d	10	10d	2855	4130
14	MSH422	1-3/4	6	10d	6	10d	--	3215	SKH414L/R <sup>6</sup>	2-1/2	20	16d	10	16d	3565	3100
16	MSH422	1-3/4	6	10d	6	10d	--	3215	SKH414L/R <sup>6</sup>	2-1/2	20	16d	10	16d	3565	3100
18	MSH422	1-3/4	6	10d	6	10d	--	3215	SKH414L/R <sup>6</sup>	2-1/2	20	16d	10	16d	3565	3100
20	MSH426	1-3/4	6	10d	6	10d	--	4340	SKH414L/R <sup>6</sup>	2-1/2	20	16d	10	16d	3565	3100
22	MSH426	1-3/4	6	10d	6	10d	--	4340	--	--	--	--	--	--	--	
24	MSH426	1-3/4	6	10d	6	10d	--	4340	--	--	--	--	--	--	--	
<b>LPI 56</b>																
<b>Joist Width = 3-1/2"</b>																
9-1/2	MSH422	1-3/4	6	10d	6	10d	--	3215	HD410_SK45L/R_BV <sup>6,8</sup>	2-1/2	18	16d	10	10d	3325	7485
11-7/8	MSH422	1-3/4	6	10d	6	10d	--	3215	HD410_SK45L/R_BV <sup>6,8</sup>	2-1/2	18	16d	10	10d	3325	7485
14	MSH422	1-3/4	6	10d	6	10d	--	3215	HD414_SK45L/R_BV <sup>6,8</sup>	2-1/2	24	16d	10	10d	3220	8250
16	MSH422	1-3/4	6	10d	6	10d	--	3215	HD414_SK45L/R_BV <sup>6,8</sup>	2-1/2	24	16d	10	10d	3220	8250

- 1) Shaded hangers require web stiffeners at joist ends.
- 2) Factored resistance is based on hanger attachment to a DF species solid sawn or LP® LVL header.
- 3) Factored uplift resistances have been increased 15% for short-term loads such as wind and earthquake; reduce for other load durations in accordance with the code.
- 4) 10d x 1-1/2 nails are 0.148" dia. x 1-1/2" long, 10d nails are 0.148" dia. x 3" long, and 16d nails are 0.162" dia. x 3-1/2" long. 16d sinkers are 0.148" dia. x 3-1/4" long and may be used where 10d commons are specified.
- 5) Hangers utilizing 16d nails are not compatible with LPI® joists.
- 6) Bevel cut required on end of joist to achieve design loads.
- 7) MSH factored resistances listed in this table assume Top-Min mounting condition installed with 4 - 10d top nails and 2 - 10d face nails. For MSH Face-Max and Top-Max mounting conditions not included in this table, refer to the current USP Product Catalog.
- 8) Hangers are special order. Consult USP for pricing and lead times.

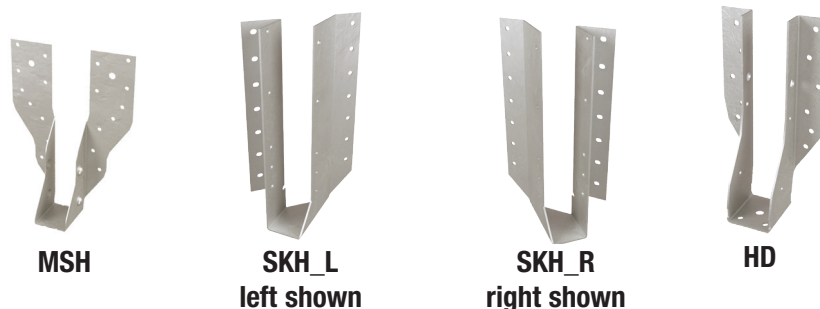

## Hanger Factored Resistance (Lbs)

Joist Height	Top Mount Hangers <sup>4,7</sup>								Face Mount Hangers							
	USP Stock No. <sup>1</sup>	Length of Hanger Seat (in)	Fastener Schedule <sup>5</sup>				Uplift <sup>3</sup> 115%	Down <sup>2</sup> 100%	USP Stock No. <sup>1</sup>	Length of Hanger Seat (in)	Fastener Schedule <sup>5</sup>				Uplift <sup>3</sup> 115%	Down <sup>2</sup> 100%
			Header		Joist						Header		Joist			
			Qty	Type	Qty	Type					Qty	Type	Qty	Type		
<b>Double LPI 18, LPI 20PLUS, LPI 32PLUS</b>																
<b>Joist Width = 5"</b>																
9-1/2	TH025950-2	3	10	16d	6	10d	2140	5090	THF25925-2	2-1/2	12	10d	6	10d	3185	5075
11-7/8	TH025118-2	3	10	16d	6	10d	2140	5090	THF25112-2	2-1/2	16	10d	6	10d	3185	5075
14	TH025140-2	3	12	16d	6	10d	2140	5090	THF25140-2	2-1/2	20	10d	6	10d	3185	6680
16	TH025160-2	3	12	16d	6	10d	2140	5090	THF25160-2	2-1/2	24	10d	6	10d	3185	6680
<b>Double LPI 42PLUS, LPI 52PLUS, LPI 56</b>																
<b>Joist Width = 7"</b>																
9-1/2	BPH7195	3	10	16d	6	10d	2935	5300	HD7100	2-1/2	12	16d	6	10d	2685	4920
11-7/8	BPH71118	3	10	16d	6	10d	2935	5300	HD7120	2-1/2	16	16d	6	10d	2685	4675
14	BPH7114	3	10	16d	6	10d	2935	5300	HD7140	2-1/2	20	16d	8	10d	2685	7485
16	BPH7116	3	10	16d	6	10d	2935	5300	HD7160	2-1/2	24	16d	8	10d	2685	8250
18	BPH7118	3	10	16d	6	10d	2935	5300	HD7180	2-1/2	28	16d	8	10d	2685	8250
20	BPH7120	3	10	16d	6	10d	2935	5300	HD7180	2-1/2	28	16d	8	10d	2685	8250
22	BPH7122	3	10	16d	6	10d	2935	5300	HD7180	2-1/2	28	16d	8	10d	2685	8250
24	BPH7124	3	10	16d	6	10d	2935	5300	HD7180	2-1/2	28	16d	8	10d	2685	8250

- 1) Shaded hangers require web stiffeners at joist ends. Web stiffeners may be required for non-shaded hangers by Louisiana-Pacific.
- 2) Factored resistance is based on hanger attachment to a DF species solid sawn or LP® LVL header.
- 3) Factored uplift resistances have been increased 15% for short-term loads such as wind and earthquake; reduce for other load durations in accordance with the code.
- 4) Top Mount Hangers assume supporting headers to have a minimum height of 5-1/2" and a minimum thickness of the length of the header nails or the depth of the top flange, whichever is greater. For wood nailer options or header materials not included in this table, refer to the current USP Product Catalog.
- 5) 10d nails are 0.148" dia. x 3" long, and 16d nails are 0.162" dia. x 3-1/2" long. 16d sinkers are 0.148" dia. x 3-1/4" long and may be used where 10d commons are specified.
- 6) Hangers utilizing 16d nails are not compatible with LPI® joists.
- 7) For top mount hangers supported by I-Joist headers with a flange thickness less than 1-1/2", consult USP and Louisiana-Pacific for hanger limitations.

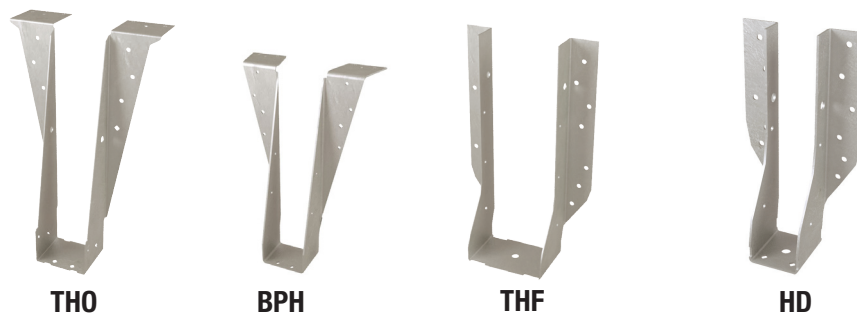

## Hanger Factored Resistance (Lbs)

Joist Height	Adjustable Height Hangers								Skewed 45° Hangers							
	USP Stock No. <sup>1,9</sup>	Length of Hanger Seat (in)	Fastener Schedule <sup>4</sup>				Uplift <sup>3</sup> 115%	Down <sup>2</sup> 100%	USP Stock No. <sup>1</sup>	Length of Hanger Seat (in)	Fastener Schedule <sup>4</sup>				Uplift <sup>3</sup> 115%	Down <sup>2</sup> 100%
			Header		Joist						Header		Joist			
			Qty	Type	Qty	Type					Qty	Type	Qty	Type		
<b>Double LPI 18, LPI 20PLUS, LPI 32PLUS</b> Joist Width = 5"																
9-1/2	See current USP Product Catalog for specialty hanger options							SKH2520L/R-2 <sup>6</sup>	3-1/2	14	10d	10	10d	3490	5320	
11-7/8	See current USP Product Catalog for specialty hanger options							SKH2520L/R-2 <sup>6</sup>	3-1/2	14	10d	10	10d	3490	5320	
14	See current USP Product Catalog for specialty hanger options							SKH2524L/R-2 <sup>6</sup>	3-1/2	16	10d	10	10d	3485	4950	
16	See current USP Product Catalog for specialty hanger options							SKH2524L/R-2 <sup>6</sup>	3-1/2	16	10d	10	10d	3485	4950	
<b>Double LPI 42PLUS, LPI 52PLUS</b> Joist Width = 7"																
9-1/2	See current USP Product Catalog for specialty hanger options							HD7100_SK45L/R_BV <sup>6,8</sup>	2-1/2	12	16d	6	10d	2015	4920	
11-7/8	See current USP Product Catalog for specialty hanger options							HD7120_SK45L/R_BV <sup>6,8</sup>	2-1/2	16	16d	6	10d	2015	4675	
14	See current USP Product Catalog for specialty hanger options							HD7140_SK45L/R_BV <sup>6,8</sup>	2-1/2	20	16d	8	10d	2015	7485	
16	See current USP Product Catalog for specialty hanger options							HD7160_SK45L/R_BV <sup>6,8</sup>	2-1/2	24	16d	8	10d	2015	8250	
18	MSH422-2 <sup>9</sup>	2	8	16d	6	16d	--	6665	HD7180_SK45L/R_BV <sup>6,8</sup>	2-1/2	28	16d	8	10d	2015	8250
20	MSH422-2 <sup>9</sup>	2	8	16d	6	16d	--	6665	HD7180_SK45L/R_BV <sup>6,8</sup>	2-1/2	28	16d	8	10d	2015	8250
22	MSH426-2 <sup>9</sup>	2	8	16d	6	16d	--	6665	HD7180_SK45L/R_BV <sup>6,8</sup>	2-1/2	28	16d	8	10d	2015	8250
24	MSH426-2 <sup>9</sup>	2	8	16d	6	16d	--	6665	HD7180_SK45L/R_BV <sup>6,8</sup>	2-1/2	28	16d	8	10d	2015	8250
<b>Double LPI 56</b> Joist Width = 7"																
9-1/2	See current USP Product Catalog for specialty hanger options							HD7100_SK45L/R_BV <sup>6,8</sup>	2-1/2	12	16d	6	10d	2015	4920	
11-7/8	See current USP Product Catalog for specialty hanger options							HD7120_SK45L/R_BV <sup>6,8</sup>	2-1/2	16	16d	6	10d	2015	4675	
14	See current USP Product Catalog for specialty hanger options							HD7140_SK45L/R_BV <sup>6,8</sup>	2-1/2	20	16d	8	10d	2015	7485	
16	See current USP Product Catalog for specialty hanger options							HD7160_SK45L/R_BV <sup>6,8</sup>	2-1/2	24	16d	8	10d	2015	8250	

- 1) Shaded hangers require web stiffeners at joist ends.
- 2) Factored resistance is based on hanger attachment to a DF species solid sawn or LP® LVL header.
- 3) Factored uplift resistances have been increased 15% for short-term loads such as wind and earthquake; reduce for other load durations in accordance with the code.
- 4) 10d nails are 0.148" dia. x 3" long, and 16d nails are 0.162" dia. x 3-1/2" long.  
16d sinkers are 0.148" dia. x 3-1/4" long and may be used where 10d commons are specified.
- 5) For additional sizes, stock numbers, and modifications not shown, refer to USP's Product Catalog.
- 6) Bevel cut required on end of joist to achieve design loads.
- 7) Hangers utilizing 16d nails are not compatible with LPI® joists.
- 8) Hangers are special order. Consult USP for pricing and lead times.
- 9) MSH factored resistances listed in this table assume Top-Min mounting condition installed with 4-10d top nails and 4-10d face nails.  
For MSH Face-Max and Top-Max mounting conditions not included in this table, refer to the current USP Product Catalog.



MSH

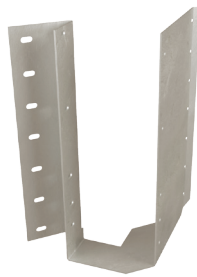

SKH\_L  
left shown



SKH\_R  
right shown



HD

## Hanger Factored Resistance (Lbs)

Joist Height	Top Mount Hangers <sup>3</sup>								Face Mount Hangers							
	USP Stock No.	Length of Hanger Seat (in)	Fastener Schedule <sup>4</sup>				Uplift <sup>2</sup> 115%	Down <sup>1</sup> 100%	USP Stock No.	Length of Hanger Seat (in)	Fastener Schedule <sup>4</sup>				Uplift <sup>2</sup> 115%	Down <sup>1</sup> 100%
			Header		Joist						Header		Joist			
			Qty	Type	Qty	Type					Qty	Type	Qty	Type		
<b>1-3/4" LP® SOLIDSTART® LVL, LSL</b>																
7-1/4	PHXU17725	3-1/4	8	16d	6	10d x 1-1/2	1890	6370	HD1770	2	14	16d	4	10d x 1-1/2	1555	3820
9-1/4	BPH17925	2-3/8	10	16d	4	10d x 1-1/2	1140	4890	HD17925	2	18	16d	6	10d x 1-1/2	2005	5710
	PHXU17925	3-1/4	8	16d	6	10d x 1-1/2	1890	6370	HUS179 <sup>5</sup>	3	30	16d	10	16d	6035	9030
9-1/2	BPH1795	2-3/8	10	16d	4	10d x 1-1/2	1140	4890	HD17925	2	18	16d	6	10d x 1-1/2	2005	5710
	PHXU1795	3-1/4	8	16d	6	10d x 1-1/2	1890	6370	HUS179 <sup>5</sup>	3	30	16d	10	16d	6035	9030
11-1/4	BPH17112	2-3/8	10	16d	4	10d x 1-1/2	1140	4890	HD17112	2	22	16d	6	10d x 1-1/2	2185	5915
	PHXU17112	3-1/4	8	16d	6	10d x 1-1/2	1890	6370	HUS179 <sup>5</sup>	3	30	16d	10	16d	6035	9030
11-7/8	BPH17118	2-3/8	10	16d	4	10d x 1-1/2	1140	4890	HD17112	2	22	16d	6	10d x 1-1/2	2185	5915
	PHXU17118	3-1/4	8	16d	6	10d x 1-1/2	1890	6370	HUS179 <sup>5</sup>	3	30	16d	10	16d	6035	9030
14	BPH1714	2-3/8	10	16d	4	10d x 1-1/2	1140	4890	HD1714	2	26	16d	8	10d x 1-1/2	3190	5925
	PHXU1714	3-1/4	8	16d	6	10d x 1-1/2	1890	6370	HUS179 <sup>5</sup>	3	30	16d	10	16d	6035	9030
16	BPH1716	2-3/8	10	16d	4	10d x 1-1/2	1140	4890	HD1714	2	26	16d	8	10d x 1-1/2	3190	5925
<b>2 Ply 1-3/4" or 3-1/2" LP® SOLIDSTART® LVL, LSL</b>																
7-1/4	PHXU35725	3-1/4	8	16d	6	10d	2355	9575	THD48	3	28	16d	16	10d	4885	8195
9-1/4	HBPH35925	3-1/2	22	16d	10	16d	5530	11005	THD410	3	38	16d	20	10d	8375	11540
	HLBH35925	6	15	NA16D-RS	6	16d	2530	14940	THDH410 <sup>5</sup>	4	46	16d	12	16d	8210	14760
9-1/2	HBPH3595	3-1/2	22	16d	10	16d	5530	11005	THD410	3	38	16d	20	10d	8375	11540
	HLBH3595	6	15	NA16D-RS	6	16d	2530	14940	THDH410 <sup>5</sup>	4	46	16d	12	16d	8210	14760
11-1/4	HBPH35112	3-1/2	22	16d	10	16d	5530	11005	THD410	3	38	16d	20	10d	8375	11540
	HLBH35112	6	15	NA16D-RS	6	16d	2530	14940	THDH412 <sup>5</sup>	4	56	16d	14	16d	9845	16130
11-7/8	HBPH35118	3-1/2	22	16d	10	16d	5530	11005	THD410	3	38	16d	20	10d	8375	11540
	HLBH35118	6	15	NA16D-RS	6	16d	2530	14940	THDH412 <sup>5</sup>	4	56	16d	14	16d	9845	16130
14	HBPH3514	3-1/2	22	16d	10	16d	5530	11005	THD410	3	38	16d	20	10d	8375	11540
	HLBH3514	6	15	NA16D-RS	6	16d	2530	14940	THDH414 <sup>5</sup>	4	66	16d	16	16d	11335	17570
16	HBPH3516	3-1/2	22	16d	10	16d	5530	11005	THD412	3	48	16d	20	10d	8375	11540
	HLBH3516	6	15	NA16D-RS	6	16d	2530	14940	THDH414 <sup>5</sup>	4	66	16d	16	16d	11335	17570
18	HBPH3518	3-1/2	22	16d	10	16d	5530	11005	THD412	3	48	16d	20	10d	8375	11540
	HLBH3518	6	15	NA16D-RS	6	16d	2530	14940	THDH414 <sup>5</sup>	4	66	16d	16	16d	11335	17570
20	HBPH3520	3-1/2	22	16d	10	16d	5530	11005	THD414 <sup>5</sup>	3	58	16d	20	10d	8375	11540
	HLBH3520	6	15	NA16D-RS	6	16d	2530	14940	THDH414 <sup>5,6</sup>	4	66	16d	16	16d	11335	17570
22	PHXU3522	3-1/4	8	16d	6	10d	2355	9575	HD418	2-1/2	28	16d	8	10d	2685	8250
	HBPH3522	3-1/2	22	16d	10	16d	5530	11005	THDH414 <sup>5,6</sup>	4	66	16d	16	16d	11335	17570
24	PHXU3524	3-1/4	8	16d	6	10d	2355	9575	HD418	2-1/2	28	16d	8	10d	2685	8250
	--	--	--	--	--	--	--	--	THDH414 <sup>5,6</sup>	4	66	16d	16	16d	11335	17570



BPH



PHXU



HBPH



HLBH

- 1) Factored resistance is based on hanger attachment to a DF species LP® LVL header.
- 2) Factored uplift resistances have been increased 15% for short-term loads such as wind and earthquake; reduce for other load durations in accordance with the code.
- 3) Top Mount Hangers assume supporting headers to have a minimum height of 5-1/2" and a minimum thickness of the length of the header nails or the depth of the top flange, whichever is greater. For wood nailer options or header materials not included in this table, refer to the current USP Product Catalog.
- 4) 10d x 1-1/2 nails are 0.148" dia. x 1-1/2" long, 10d nails are 0.148" dia. x 3" long, and 16d nails are 0.162" dia. x 3-1/2" long, NA16D-RS are 10d (0.148" dia.) x 3-1/2" long ring shank nails. 16d sinkers are 0.148" dia. x 3-1/4" long and may be used where 10d commons are specified.
- 5) Joist nails need to be toe nailed at a 30° to 45° angle to achieve listed loads for THDH and HUS models.
- 6) Supplemental lateral support connection recommended when hanger height is less than 60% of joist height.



HD



HUS



THD

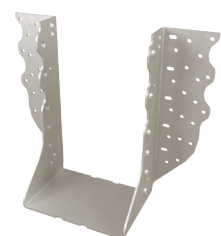

THDH



## Hanger Factored Resistance (Lbs)

Joist Height	Top Mount Hangers <sup>3</sup>								Face Mount Hangers							
	USP Stock No. <sup>6</sup>	Length of Hanger Seat (in)	Fastener Schedule <sup>4</sup>				Uplift <sup>2</sup> 115%	Down <sup>1</sup> 100%	USP Stock No. <sup>6</sup>	Length of Hanger Seat (in)	Fastener Schedule <sup>4</sup>				Uplift <sup>2</sup> 115%	Down <sup>1</sup> 100%
			Header		Joist						Header		Joist			
			Qty	Type	Qty	Type					Qty	Type	Qty	Type		
<b>3 Ply 1-3/4" LP® SOLIDSTART® LVL, LSL</b>																
7-1/4	BPH55725	2-1/4	10	16d	6	10d	2935	5300	--	--	--	--	--	--	--	
9-1/4	HBP55925	3-1/2	22	16d	10	16d	5620	10405	THD610	3	38	16d	20	10d	6425	12455
	HLB55925	6	15	NA16D-RS	6	16d	2860	14940	THDH610 <sup>5</sup>	4	46	16d	16	16d	10140	12645
9-1/2	HBP5595	3-1/2	22	16d	10	16d	5620	10405	THD610	3	38	16d	20	10d	6425	12455
	HLB5595	6	15	NA16D-RS	6	16d	2860	14940	THDH610 <sup>5</sup>	4	46	16d	16	16d	10140	12645
11-1/4	HBP55112	3-1/2	22	16d	10	16d	5620	10405	THD610	3	38	16d	20	10d	6425	12455
	HLB55112	6	15	NA16D-RS	6	16d	2860	14940	THDH612 <sup>5</sup>	4	56	16d	20	16d	10140	15465
11-7/8	HBP55118	3-1/2	22	16d	10	16d	5620	10405	THD610	3	38	16d	20	10d	6425	12455
	HLB55118	6	15	NA16D-RS	6	16d	2860	14940	THDH612 <sup>5</sup>	4	56	16d	20	16d	10140	15465
14	HBP5514	3-1/2	22	16d	10	16d	5620	10405	THD610	3	38	16d	20	10d	6425	12455
	HLB5514	6	15	NA16D-RS	6	16d	2860	14940	THDH614 <sup>5</sup>	4	66	16d	22	16d	11335	17570
16	HBP5516	3-1/2	22	16d	10	16d	5620	10405	THD612	3	48	16d	20	10d	9850	13785
	HLB5516	6	15	NA16D-RS	6	16d	2860	14940	THDH614 <sup>5</sup>	4	66	16d	22	16d	11335	17570
18	HBP5518	3-1/2	22	16d	10	16d	5620	10405	THD612	3	48	16d	20	10d	9850	13785
	HLB5518	6	15	NA16D-RS	6	16d	2860	14940	THDH614 <sup>5</sup>	4	66	16d	22	16d	11335	17570
20	HBP5520	3-1/2	22	16d	10	16d	5620	10405	THD614 <sup>8</sup>	3	58	16d	20	10d	9850	13785
	HLB5520	6	15	NA16D-RS	6	16d	2860	14940	THDH614 <sup>5</sup>	4	66	16d	22	16d	11335	17570
22	XHLB5522 <sup>7</sup>	6	15	NA16D-RS	6	16d	2860	14940	THD614 <sup>8</sup>	3	58	16d	20	10d	9850	13785
	--	--	--	--	--	--	--	--	THDH614 <sup>5</sup>	4	66	16d	22	16d	11335	17570
24	XHLB5524 <sup>7</sup>	6	15	NA16D-RS	6	16d	2860	14940	THD614 <sup>8</sup>	3	58	16d	20	10d	9850	13785
	--	--	--	--	--	--	--	--	THDH614 <sup>5</sup>	4	66	16d	22	16d	11335	17570
<b>4 Ply 1-3/4" or 2 Ply LP® SOLIDSTART® LVL, LSL</b>																
9-1/4	HBP71925	3-1/2	22	16d	10	16d	5620	10405	THD7210	3	38	16d	20	10d	6425	12455
	HLB71925	6	15	NA16D-RS	6	16d	2860	14940	THDH7210 <sup>5</sup>	4	46	16d	12	16d	8210	12645
9-1/2	HBP7195	3-1/2	22	16d	10	16d	5620	10405	THD7210	3	38	16d	20	10d	6425	12455
	HLB7195	6	15	NA16D-RS	6	16d	2860	14940	THDH7210 <sup>5</sup>	4	46	16d	12	16d	8210	12645
11-1/4	HBP71112	3-1/2	22	16d	10	16d	5620	10405	THD7210	3	38	16d	20	10d	6425	12455
	HLB71112	6	15	NA16D-RS	6	16d	2860	14940	THDH7212 <sup>5</sup>	4	56	16d	14	16d	9845	12645
11-7/8	HBP71118	3-1/2	22	16d	10	16d	5620	10405	THD7210	3	38	16d	20	10d	6425	12455
	HLB71118	6	15	NA16D-RS	6	16d	2860	14940	THDH7212 <sup>5</sup>	4	56	16d	14	16d	9845	12645
14	HBP7114	3-1/2	22	16d	10	16d	5620	10405	THD7210	3	38	16d	20	10d	6425	12455
	HLB7114	6	15	NA16D-RS	6	16d	2860	14940	THDH7214 <sup>5</sup>	4	66	16d	16	16d	11335	17570
16	HBP7116	3-1/2	22	16d	10	16d	5620	10405	HD7120	2-1/2	16	16d	6	10d	2685	4675
	HLB7116	6	15	NA16D-RS	6	16d	2860	14940	THDH7214 <sup>5</sup>	4	66	16d	16	16d	11335	17570
18	HBP7118	3-1/2	22	16d	10	16d	5620	10405	HD7140	2-1/2	20	16d	8	10d	2685	7485
	HLB7118	6	15	NA16D-RS	6	16d	2860	14940	THDH7214 <sup>5</sup>	4	66	16d	16	16d	11335	17570
20	HBP7120	3-1/2	22	16d	10	16d	5620	10405	HD7140	2-1/2	20	16d	8	10d	2685	7485
	HLB7120	6	15	NA16D-RS	6	16d	2860	14940	THDH7214 <sup>5</sup>	4	66	16d	16	16d	11335	17570
22	HBP7122	3-1/2	22	16d	10	16d	5620	10405	HD7180	2-1/2	28	16d	8	10d	2685	8250
	HLB7122	6	15	NA16D-RS	6	16d	2860	14940	THDH7214 <sup>5</sup>	4	66	16d	16	16d	11335	17570
24	HBP7124	3-1/2	22	16d	10	16d	5620	10405	HD7180	2-1/2	28	16d	8	10d	2685	8250
	HLB7124	6	15	NA16D-RS	6	16d	2860	14940	THDH7214 <sup>5</sup>	4	66	16d	16	16d	11335	17570



BPH



HBP



HLB



THD



HD

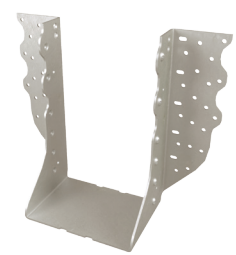

THDH

- Factored resistance is based on hanger attachment to a DF species LP® LVL header.
- Factored uplift resistances have been increased 15% for short-term loads such as wind and earthquake; reduce for other load durations in accordance with the code.
- Top Mount Hangers assume supporting headers to have a minimum height of 5-1/2" and a minimum thickness of the length of the header nails or the depth of the top flange, whichever is greater. For wood nailer options or header materials not included in this table, refer to the current USP Product Catalog.
- 10d nails are 0.148" dia. x 3" long, and 16d nails are 0.162" dia. x 3-1/2" long, NA16D-RS are 10d (0.148" dia.) x 3-1/2" long ring shank nails. 16d sinkers are 0.148" dia. x 3-1/4" long and may be used where 10d commons are specified.
- Joist nails need to be toe nailed at a 30° to 45° angle to achieve listed loads for THDH models.
- For additional sizes, stock numbers, and modifications not shown, refer to USP's Product Catalog.
- Hangers are special order. Consult USP for pricing and lead times.
- Supplemental lateral support connection recommended when hanger height is less than 60% of joist height.

# Field Slope/Skew Hangers

The LSSH series connects rafters to ridge beams in vaulted roof structures. This series is field adjustable to meet a variety of skew and/or slope applications. Slopes and skews 0° to 45°.

### Installation:

- Use all specified fasteners.

### Steps:

1. Position LSSH connector against plumb-cut end of joist. Fasten joist side flanges on both sides with 10d (0.148") x 1-1/2" nails. Bend seat up to fit against joist bottom and drive (1) 10d (0.148") x 1-1/2" nail through bottom seat into joist bottom flange. Drive (2) 10d (0.148") x 1-1/2" nail at downward angle through dimpled nailing guides.
  2. Lean connector and rafter end against ridge beam at desired position. Install 10d (0.148" x 3") or 16d (0.162" x 3-1/2") nails through nail holes into ridge beam at right 90° angle. If skewing the rafter, only drive nails into ridge beam on inside flange.
  3. Bend flange to desired angle.
  4. Hammer outside flange until edge touches header. Fasten outside flange to ridge by driving 10d (0.148" x 3") or 16d (0.162" x 3-1/2") nails through nail holes.
- Web stiffeners are required for all wood I-Joist installations.
  - Designer may consider adding a tension restraint for the supported member for roof slopes exceeding 6/12.

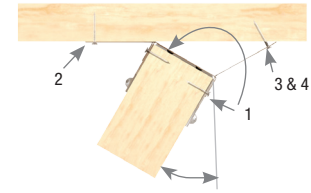

Skew to 45° maximum



Typical LSSH installation

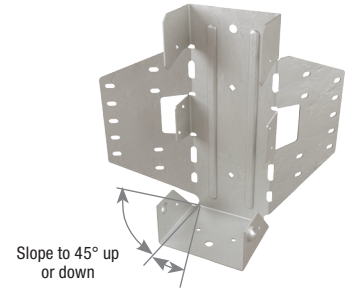

Slope to 45° up or down

LSSH

## Hanger Factored Resistance (Lbs)

Joist Height	USP Stock No. <sup>1</sup>	Length of Hanger Seat (in)	Installation Type	Fastener Schedule <sup>4</sup>				DF	
				Header		Joist		Uplift <sup>3</sup> 115%	Down <sup>2</sup> 100%
				Qty	Type	Qty	Type		
<b>LPI 18, LPI 20PLUS, LPI 32PLUS</b>									
<b>Joist Width = 2-1/2"</b>									
All	LSSH25	3	Sloped Only	18	16d	12	10d x 1-1/2	1895	4125
			Skewed Only <u>or</u> Sloped & Skewed	14	16d	12	10d x 1-1/2	1895	2895
<b>LPI 42PLUS, LPI 52PLUS, LPI 56</b>									
<b>Joist Width = 3-1/2"</b>									
All	LSSH35	3	Sloped Only	18	16d	12	10d x 1-1/2	2515	5065
			Skewed Only <u>or</u> Sloped & Skewed	14	16d	12	10d x 1-1/2	2515	3045

- 1) Shaded hangers require web stiffeners at joist ends.
- 2) Factored resistance is based on hanger attachment to a DF species solid sawn or LP<sup>®</sup> LVL header.
- 3) Factored uplift resistances have been increased 15% for short-term loads such as wind and earthquake; reduce for other load durations in accordance with the code.
- 4) 10d x 1-1/2 nails are 0.148" dia. x 1-1/2" long, 10d nails are 0.148" dia. x 3" long, 16d nails are 0.162" dia. x 3-1/2" long.
- 5) Hangers utilizing 16d nails are not compatible with LPI 56 joists.
- 6) Supplemental lateral support connection recommended when hanger height is less than 60% of joist height.

# Variable Pitch Connectors

The TMP and TMPH are designed to make rafter-to-plate connections and eliminate time-consuming bird's-mouth notching or bevel plate installation.

### Installation:

- Use all specified fasteners.
- Position connector on top plate. Fasten connector to outside of top plate with specified nails. Insert rafter into rafter pocket. Adjust rafter and pocket to correct pitch. Fasten rafter to connector with specified nails. For **TMP**: drive specified nails through the opposing slots in the pocket. For **TMPH**: slide the fulcrum until it supports the pocket at the desired pitch and drive nails down through the fulcrum base into the top plate to lock the fulcrum into position.

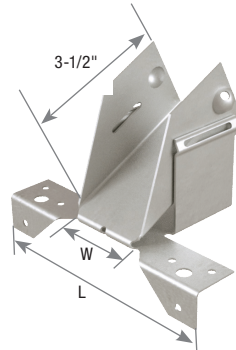
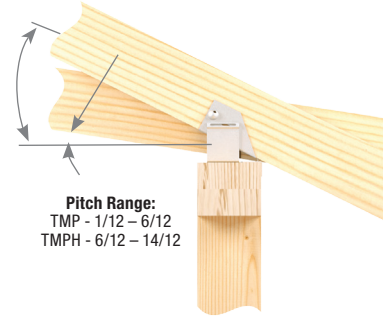

TMP



Typical TMP installation



Typical TMPH installation

### TMP Hanger Factored Resistance (Lbs)

Joist Height	USP Stock No.	Dimensions (in)		Fastener Schedule <sup>4</sup>				DF	
		W	L	Header Qty	Header Type	Joist Qty	Joist Type	Uplift <sup>3</sup> 115%	Down <sup>2</sup> 100%
<b>LPI 18, LPI 20PLUS, LPI 32PLUS</b> Joist Width = 2-1/2"									
All	TMP25	2-11/16	6-3/8	6	10d	4	10d x 1-1/2	400	2770
<b>LPI 42PLUS, LPI 52PLUS, LPI 56</b> Joist Width = 3-1/2"									
All	TMP4	3-9/16	7-5/16	6	10d	4	10d x 1-1/2	400	2770

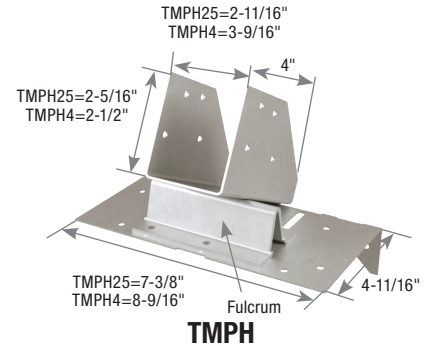

TMPH

- 1) Web stiffeners are required for all Wood I-Joist installations.
- 2) Factored resistance is based on hanger attachment to a DF species solid sawn or LP® LVL header.
- 3) Factored uplift resistances have been increased 15% for short-term loads such as wind and earthquake; reduce for other load durations in accordance with the code.
- 4) **NAILS:** 10d x 1-1/2 nails are 0.148" dia. x 1-1/2" long, 10d nails are 0.148" dia. x 3" long.

### TMPH Hanger Factored Resistance (Lbs)

Joist Height	USP Stock No.	Fastener Schedule <sup>4</sup>				Uplift <sup>3</sup> 115%	DF								
		Plate		Rafter			According to Pitch <sup>2</sup>								
		Qty	Type	Qty	Type		6/12	7/12	8/12	9/12	10/12	11/12	12/12	13/12	14/12
<b>LPI 18, LPI 20PLUS, LPI 32PLUS</b> Joist Width = 2-1/2"															
All	TMPH25	10	10d	8	10d x 1-1/2	375	5220	5385	5540	5005	4470	4305	4120	3655	3185
<b>LPI 42PLUS, LPI 52PLUS, LPI 56</b> Joist Width = 3-1/2"															
All	TMPH4	10	10d	8	10d x 1-1/2	375	5220	5385	5540	5005	4470	4305	4120	3655	2605

- 1) Web stiffeners are required for all Wood I-Joist installations.
- 2) Factored resistance is based on hanger attachment to a DF species solid sawn or LP® LVL header.
- 3) Factored uplift resistances have been increased 15% for short-term loads such as wind and earthquake; reduce for other load durations in accordance with the code.
- 4) **NAILS:** 10d x 1-1/2 nails are 0.148" dia. x 1-1/2" long, 10d nails are 0.148" dia. x 3" long.

## WS Series Wood Screw Applications - Joining 2, 3, or 4 Ply LP® LVL Members

### Installation:

- Screws are self-drilling.
- Install using a low speed clutch drill with 3/8" hex head driver. The washer head should be flat to the surface and the serrations will oppose turning and release the clutch. Do not over-tighten the screws.
- For 2 ply members, wood screws shall be installed with the screw heads in the loaded ply.
- For 3 or 4 ply members, wood screws shall be installed in both outer plies.
- Designer shall specify all wood screw locations.
- Increase edge and end distances if wood splitting occurs.
- Stagger all screws installed into the opposite face.
- A minimum of 2 rows of screws shall be used for all members 5-1/2" and deeper.

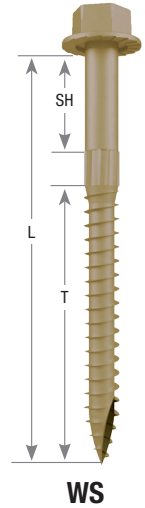
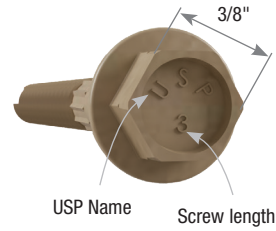

### Recommended Row Guidelines

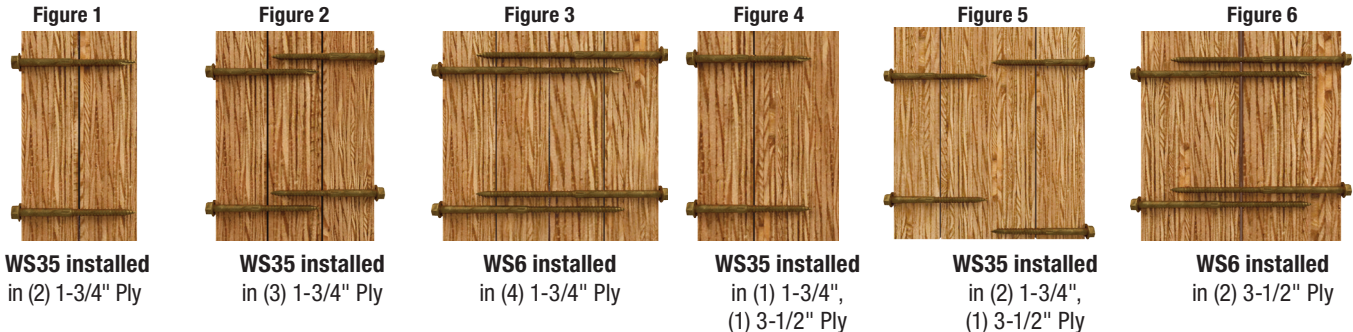
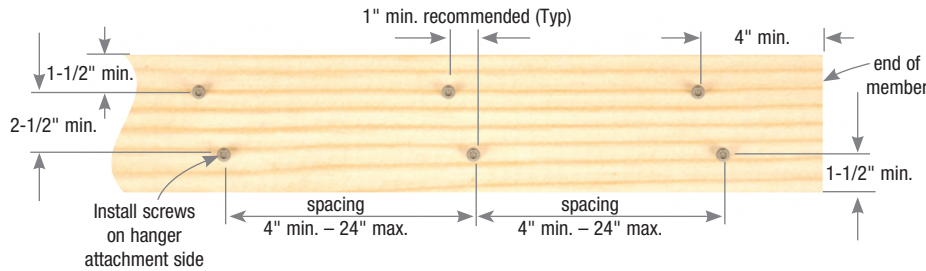

Size (in)	USP Stock No.	Dimensions (in)			Multiple Members Installation Figure <sup>3,7,9,10</sup>	Maximum Factored Uniform Loads that can be applied to either outside member <sup>1,2,3,4,5,6</sup>											
		L	SH	T		Wood Screw Spacing											
						12-in O.C.		18-in O.C.		24-in O.C.							
						2 Rows	3 Rows	2 Rows	3 Rows	2 Rows	3 Rows						
Lbs/ft		kN/m		Lbs/ft		kN/m		Lbs/ft		kN/m		Lbs/ft		kN/m			
1/4 x 3-1/2	WS35	3-1/2	3/4	2-1/2	1	1845	26.93	2765	40.35	1230	17.95	1845	26.93	920	13.43	1385	20.21
					2	1385	20.21	2075	30.28	920	13.43	1385	20.21	690	10.07	1035	15.11
					4	1385	20.21	2075	30.28	920	13.43	1385	20.21	690	10.07	1035	15.11
					5	1230	17.95	1845	26.93	820	11.97	1230	17.95	615	8.98	920	13.43
1/4 x 6	WS6 <sup>8</sup>	6	1-3/4	4	3	1560	22.77	2340	34.15	1040	15.18	1560	22.77	780	11.38	1170	17.08
					6	5470	79.83	8210	119.82	3650	53.27	5470	79.83	2735	39.92	4105	59.91

1) Factored Resistance values determined in accordance with CSA O86-14 Clause 12.11.  
 2) Loads are based on SCL with an equivalent S.G. = 0.50 and a side member thickness of 1-3/4", except for Figure 6 installation with a side member thickness of 3-1/2".  
 3) Load values depicted assume that the uniform load is applied to the most narrow outside ply only.  
 4) Except for Figure 6 installation, load values neglect any contribution of screws installed to opposite side, even if they extend significantly into the loaded ply.  
 5) Loads are for normal (100%) duration of load, and may be increased in accordance with the code.  
 6) Uniform loads in table represent the capacity of the fasteners. The capacity of the LVL or PSL beam may be less and should be checked by a qualified designer or with the manufacturer's literature.  
 7) A qualified designer shall ensure the adequacy of a 7" wide beam to resist the applied load on one edge; otherwise, the loads shall be uniformly distributed across the width or applied equally on both sides.  
 8) Wood screws longer than 3-1/2" are not recommended for use with Parallam® PSL or TimberStrand® LSL.  
 9) For Figure 1: The head of the wood screw is on the same side as the loaded ply.  
 10) For Figures 2, 3, 5, and 6: Stagger the screws on opposite face by half minimum spacing requirements.

# Specification Tools

All available on our Web Site  
@ USPconnectors.com

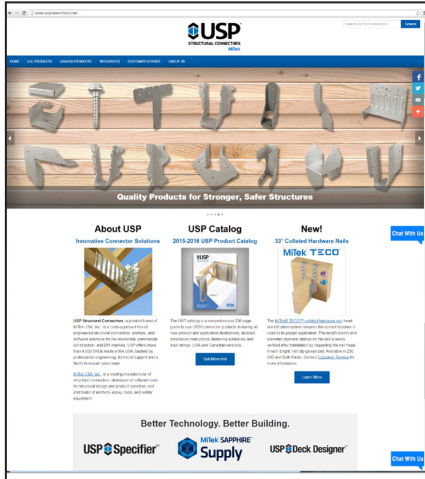

## Comprehensive Web Site

- Contains all USP literature in a printable .pdf format
- Drawing Library downloads

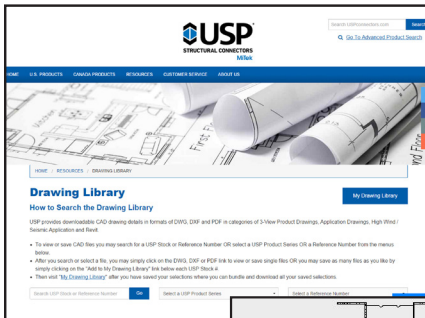

## Drawing Library

- Drawing Library contains over 350 illustrations in .DXF and .DWG formats
- Find drawings quickly by USP Stock No. or Reference No.
- High Wind/Seismic Applications are also available

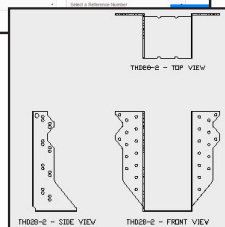

Customer Service  
Phone: 1-855-633-2725  
Fax: 1-905-952-2903  
Email: ca-customer-service@mitek.ca

Manufacturing:  
Montgomery, MN • Phoenix, AZ  
Largo, FL • Thornhill, ON

Warehouses:  
Surrey, BC • Calgary, AB  
Edmonton, AB • Laval, QC • Dieppe, NB

USPconnectors.com

©Copyright 2016 MiTek USA, Inc.  
Revised November 2016.